

manual

gb5 & fb80

Named for Giovanna Bambi and designed with classic La Marzocco styling and spirit, the GB/5 combines harmonious aesthetics and powerful technological advancements. With gracious lines and curves. The GB/5 is an understated companion to any coffee bar, while its unmatched temperature stability provides steady brew water and steam even at the peak of the morning rush.



la marzocco

handmade in florence

gb5 & fb80

Operating Manual V1.3 - 11/2014



la marzocco

handmade in florence

Chapters

1. General Warnings and Safety Specifications	page 2
2. Definition of Available Models	page 4
3. Installation	page 6
4. Machine Operation and Coffee Preparation	page 9
5. Dispensing Steam and Hot Water	page 11
6. Maintenance and Periodic Cleaning Operations	page 12
7. De-commissioning and Demolition	page 15
8. Mandatory Maintenance and Check-up Operations	page 16
9. Software Programming Guide	page 17

La Marzocco S.r.l.

Via La Torre 14/H
Località La Torre
50038 Scarperia e San Piero
(Firenze) - ITALIA

www.lamarzocco.com
info@lamarzocco.com

T: +39 055 849 191
F: +39 055 849 1990

certifications available:



1. General Warnings and Safety Specifications

WARNING

THIS MACHINE IS FOR PROFESSIONAL USE ONLY AND SHOULD BE INSTALLED IN LOCATIONS WHERE ITS USE AND MAINTENANCE IS RESTRICTED TO TRAINED PERSONNEL. CHILDREN ARE FORBIDDEN TO OPERATE OR PLAY WITH THE MACHINE.

1) This operating manual is an integral and essential part of the product and must be supplied to users. Users are asked to read the enclosed warnings and cautions carefully, as they provide valuable information concerning safety during installation, operation and maintenance. This manual must be kept in a safe place and be available for consultation to new and experienced users alike.

2) Ensure product's integrity by inspecting the packaging, making sure it presents no signs of damage which might have affected the enclosed machine.

3) Check the machine's integrity after having carefully removed the packaging.
Note: In case of doubt, do not go on any further and contact your dealer or retailer immediately. They will send out specialized personnel authorized to perform service on the espresso machine.

4) Packaging (boxes, plastic bags, foam parts and whatever else) must not be left around within easy reach of children, due

to the potential danger it represents, nor be discarded in the environment.

5) Check to see that data on the rating plate corresponds to those of the main electrical supply which the machine will be hooked up to.

6) The equipment must be installed to comply with the applicable federal, state or local electrical and plumbing codes. The installation also must comply to the manufacturer's instructions, and must be performed by qualified and authorized personnel.

7) Incorrect installation may cause injury/damages to people, animals or objects, for which the manufacturer shall not be held responsible.

8) Safe electrical operation of this device will be achieved only when the connection to the power outlet has been completed correctly and in observance of all local, national, and international electrical codes and safety regulations, and particularly by grounding the unit. Make sure grounding has been done properly as it represents a fundamental safety requirement. Ensure qualified personnel check such connection.

9) Furthermore, you must ensure that the capacity of the available electrical

system is suitable for the maximum power consumption indicated on the espresso machine.

10) We do not recommend using adapters, multiple plugs and/or extension cords. If you cannot avoid using them, make sure that they are exclusively of the kind which conforms to local, national, and international electrical codes and safety regulations, being careful not to exceed the power and current ratings indicated on such adapters and extension cords.

11) This device must be used exclusively for the functions it has been designed and built for. Any other application is inappropriate and dangerous.

The manufacturer shall not be held responsible for any damages caused by improper and/or irrational use.

This machine should not be installed in kitchens.

12) Using any electrical device requires that certain fundamental rules be observed. In particular:

- do not touch the device with wet or humid hands and feet;
- do not use the device while having no shoes on your feet;
- do not use extension cords in bath or shower rooms;
- do not unplug the device from the

power outlet by pulling on the power supply cable;

- do not expose the device to atmospheric agents (rain, sun, etc.);
- do not allow children or untrained people to use this device;
- do not clean the control panel with a wet cloth since it is not watertight.

13) Before carrying out any maintenance and/or cleaning operations, turn the main switch, which is located on the front left of the machine, to the “0” or OFF position, and disconnect the machine from the electrical network by unplugging the cord or by switching off the relevant circuit breaker. For any cleaning operation, follow exclusively the instructions contained in this manual.

14) When the machine is operating in a faulty manner or breaks down, disconnect it from the electrical network (as described in the preceding point) and close the water supply valve. Do not attempt to repair it. Contact a qualified and authorized professional to perform any repair. Any repairs must be performed exclusively by the manufacturer or by an authorized agent using only original parts. Non compliance with the above could compromise the safe operation of the machine.

15) You should plan to make use of an omnipolar connector during installation, as required by local, national, and international

electrical codes and regulations.

16) In order to avoid dangerous overheating problems, it is recommended that the power supply cable be fully unfurled.

17) Do not obstruct air intake and exhaust grilles and, in particular, do not cover the cup warmer tray with cloths or other items.

18) The machine’s power supply cable must not be replaced by users. In case the power supply cable becomes damaged, shut off the machine and disconnect the machine from the electrical network by switching off the relevant circuit breaker and close off the water supply; to replace the power supply cord, contact qualified professionals exclusively.

⚠ WARNING ⚠

AS ALREADY MENTIONED IN THE PRECEDING NOTES, THE MANUFACTURER SHALL NOT BE HELD RESPONSIBLE FOR DAMAGE TO OBJECTS, ANIMALS AND/OR PEOPLE WHENEVER THE MACHINE HAS NOT BEEN INSTALLED ACCORDING TO THE INSTRUCTIONS CONTAINED IN THIS MANUAL, AND IS NOT USED TO DO WHAT IT WAS DESIGNED FOR (I.E. PREPARING COFFEE AND HOT DRINKS).

⚠ WARNING ⚠

THIS MACHINE IS NOT SUITABLE FOR OUTDOOR USE. JETS OF WATER SHOULD NOT BE USED TO CLEAN THE MACHINE, NOR SHOULD IT BE PLACED WHERE WATER JETS ARE USED.

Everything set out in this operating manual is also valid for the “FB/80” series. The only differences are the external dimensions of the machine.

⚠ WARNING ⚠

THE COFFEE MACHINE MUST BE PLACED IN A HORIZONTAL POSITION ON A COUNTER HIGHER THAN 80 CM FROM THE GROUND.

1) Common Dimensions, Weights, and Features

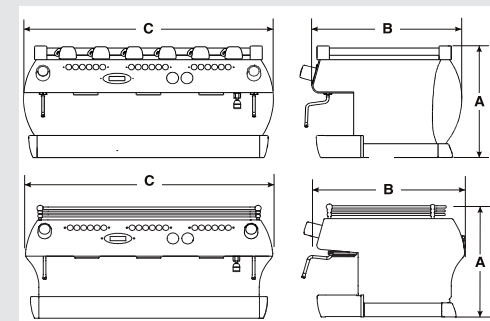

GB/5	2 gr.		3 gr.		4 gr.	
FB/80						
A [mm]	475	485	475	485	475	485
B [mm]	622	627	622	627	622	627
C [mm]	750	755	950	955	1190	1195
WEIGHT [kg]	63	63	77	79	107	105

2. Definition of Available Models

This operating manual refers exclusively to the following models, of our own manufacture:

GB/5 or FB/80, Model EE & AV and MP into 2, 3 and 4 groups

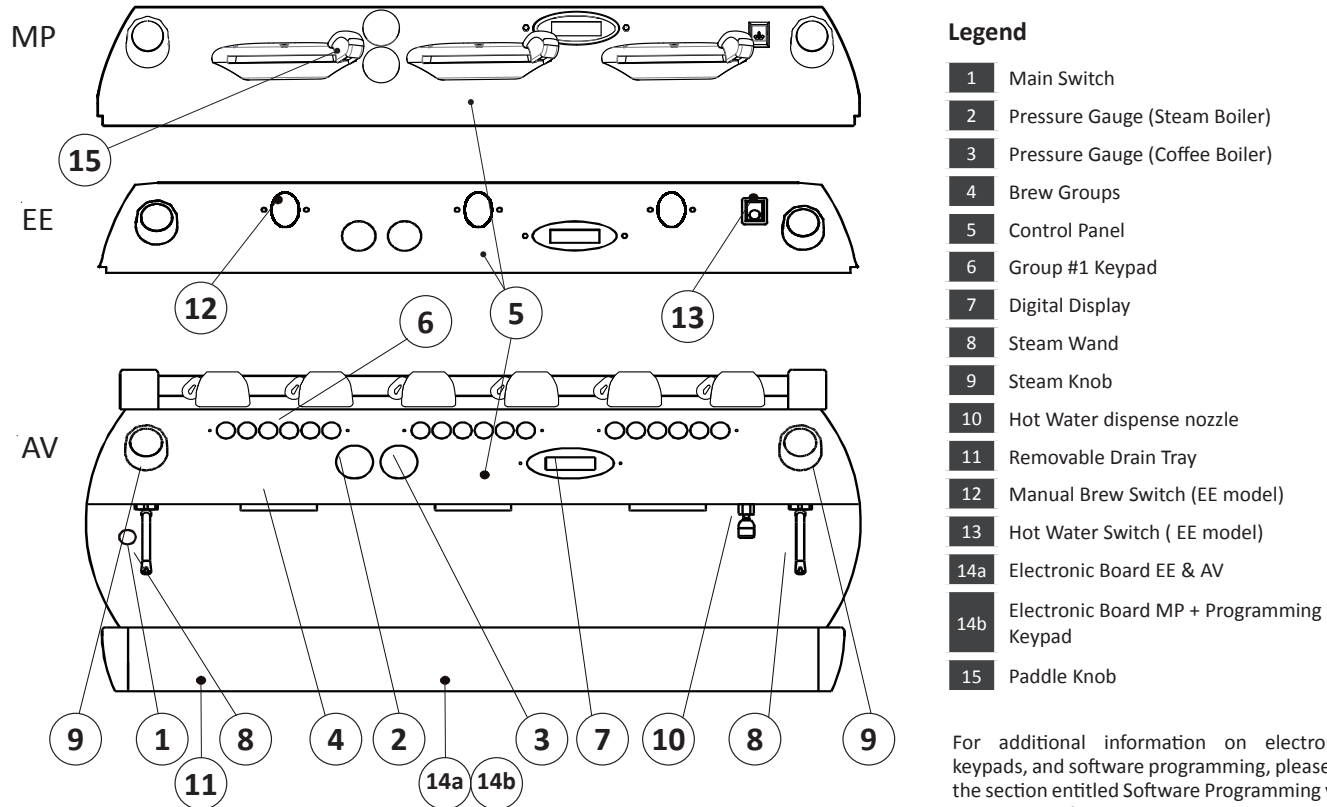

Fig. 1 - Model AV & EE with 2, 3, or 4 groups

For additional information on electronics, keypads, and software programming, please see the section entitled Software Programming your Espresso Machine.

1) General description

The machine is built in 2, 3, and 4 group versions and is essentially composed of the following parts:

- Steam Boiler (produces steam and hot water)
- Coffee (“saturation”) boiler
- Brewing groups
- Exterior Cover
- Water pump

2) Description of the various parts

• Steam Boiler

The Steam Boiler consists of a cylindrical tank, of varying length according to the number of coffee groups, which is made of AISI 300 series stainless steel. Each unit is subjected to a bench test, at a pressure of 6 bar, and has an operating pressure of 1.3-1.5 bar. The following is a list of effective volumes and power ratings according to the number of groups installed:

2 groups 7.0 liters	2000 or 3000 Watts
3 groups 11 liters	3000 or 4000 Watts
4 groups 15 liters	3800 or 5000 Watts

Covers are installed at either end of the cylindrical tank and on one of them there is a housing for the water-heating element, which allows the steam boiler to reach operating pressure within approximately 25 minutes. Operating pressure is maintained by a pressure switch or a temperature probe. The steam boiler has various fittings used for safety

devices, hot water, steam, and for the heating element.

• Coffee boiler

The Coffee Boiler consists of a cylindrical tank, of varying length according to the number of coffee groups, which is made of AISI 300 series stainless steel. Each unit is subjected to a hydraulic test, at a pressure of 18 bar, and has an operating pressure of 9 bar. The following table is a list of effective volumes and power ratings according to the number of groups installed:

2 groups 3.4 liters	1400 Watts
3 groups 5.0 liters	1600 or 1900 Watts
4 groups 3.4 + 3.4 liters	1400 + 1400 Watts (2 Boilers Installed)

Covers are installed at either end of the cylindrical tank and on one of them there is a housing for the water heating elements. The temperature of the coffee boiler is maintained by an electronic temperature controller (PID capable) with an accuracy of 0.2°C. The brewing groups are installed on the boiler.

• Brewing groups

They consist of a precision casting made of stainless steel. The brewing group accepts the portafilter used to hold the ground coffee; Hot water under pressure flows through the brewing group, through the portafilter basket, through the portafilter

spout, and into the cup(s) after the brew button has been pressed preparing espresso.

• Exterior cover

It consists of a stainless sheet steel body for the GB/5 and painted plastic for FB/80. The structure has been the object of specific studies to provide good aesthetics, to lower ergonomic costs for the operator and to reduce the chance of damage to a minimum.

• Water pump

The water pump, is a differential pressure, “positive-displacement” type installed on the water supply tubing and is set-up to operate anytime the coffee groups are activated, and through an autofill system whenever the steam boiler needs to be replenished.

• Sound pressure

The weighted sound pressure level of the machine is lower than 70dBa.

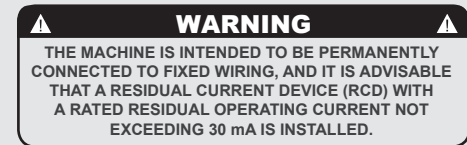

3. Installation

WARNING

THE COFFEE BOILER AND STEAM BOILER CONTAIN WATER AT ELEVATED TEMPERATURE. WATER TEMPERATURE OVER 125°F / 52°C CAN CAUSE SEVERE BURNS INSTANTLY OR DEATH FROM SCALDING (COFFEE BOILER 207°F/97°C-STEAM BOILER 256°F /124°C)

WARNING

THIS APPLIANCE IS NOT INTENDED FOR USE BY PERSONS (INCLUDING CHILDREN) WITH REDUCED PHYSICAL, SENSORY OR MENTAL CAPABILITIES, OR WITH LACK OF EXPERIENCE AND KNOWLEDGE, UNLESS THEY HAVE BEEN GIVEN SUPERVISION OR INSTRUCTION CONCERNING THE USE OF THE APPLIANCE BY A PERSON RESPONSIBLE FOR THEIR SAFETY.

MODEL/SERIES	GROUP	V/Hz	RATED POWER (W)	RATED INPUT (A)	COFFEE BOILER WATTAGE	STEAM BOILER WATTAGE	TOTAL WATTAGE	POWER CORD SIZE (mm ²)
GB/5	2GR	AC220V/50-60Hz AC208V-240V/50-60Hz AC380V/50-60Hz	4600	21	1400	3000	4600	3/5 WIRES x 4mm ²
FB/80	2GR	AC220V/50-60Hz AC208V-240V/50-60Hz AC380V/50-60Hz	4600	21	1400	3000	4600	3/5 WIRES x 4mm ²
GB/5	3GR	AC220V/50-60Hz AC208V-240V/50-60Hz AC380V/50-60Hz	6100	28	1900	4000	6100	3/5 WIRES x 6mm ²
FB/80	3GR	AC220V/50-60Hz AC208V-240V/50-60Hz AC380V/50-60Hz	6100	28	1900	4000	6100	3/5 WIRES x 6mm ²
GB/5	4GR	AC220V/50-60Hz AC208V-240V/50-60Hz AC380V/50-60Hz	8000	35	2800	5000	8000	3/5 WIRES x 10mm ²
FB/80	4GR	AC220V/50-60Hz AC208V-240V/50-60Hz AC380V/50-60Hz	8000	35	2800	5000	8000	3/5 WIRES x 10mm ²

3 X WIRES 220V

1 X BLUE (NEUTRAL)
1 X BROWN (PHASE)
1 X YELLOW & GREEN (GROUND)



POWER CORD:

5 X WIRES 380V

1 X BROWN (PHASE)
1 X GRAY (PHASE)
1 X BLACK (PHASE)
1 X BLUE (NEUTRAL)
1 X YELLOW & GREEN (GROUND)



WARNING

THE DETAILS ON THE LEFT DESCRIBE HOW TO CONNECT EACH WIRE TO THE PLUG. RESPECT ALSO THE LOCAL SAFETY REGULATIONS.

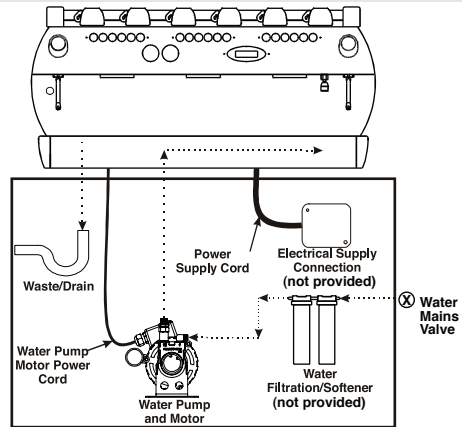

Fig. 2 - Installation Guide

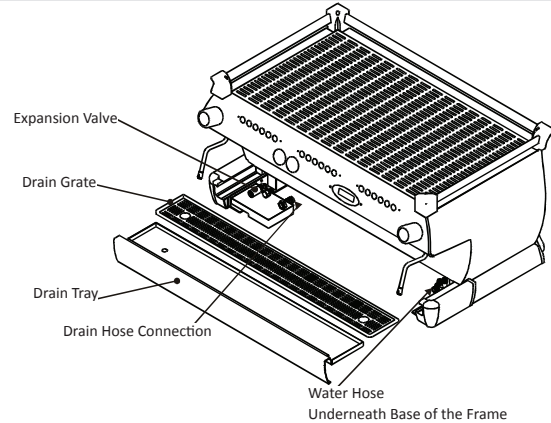

Fig. 3 - Installation Nomenclature

1) Accessories

▲ WARNING ▲
AT EACH INSTALLATION, THE MACHINE SHOULD BE EQUIPPED WITH A NEW SET OF TUBES FOR PLUMBING AND RELATED GASKETS.

Check the package to make sure that the following accessories are included:

- a number of 1-dose and 2-dose portafilters corresponding to the number of groups;
- replacement 1-dose and 2-dose filters (one of each)
- 1 tamper
- 1 blind filter
- cleaning detergent, for the groups
- 3 stainless steel braided hoses for water connections
- 1,5 mt of reinforced plastic tubing for drainage
- 1 hose clamp

In order to proceed with installation, it is necessary that the following are available:

- Pipes carrying drinking water with a **3/8" G (BSP)** end connection; (**3/8" Compression for USA and Canada**)
- Electrical Supply according to the specification of the espresso machine purchased:
- Single/Three phase 220VAC - 50/60 Hz electrical connection with ground, protected socket and approved

interlock switch

- Single phase 200VAC - 50/60 Hz electrical connection with ground, protected socket and approved interlock switch
- Three-phase, 380VAC - 50 Hz electrical connection with neutral + ground, near the bench on which the machine is installed and terminating in a suitable protected fivepole socket equipped with an approved interlock switch
- Waste water drain system

Note:

- The drinking water mains valve and the circuit breakers for the electrical system need to be located in the most convenient position for the operator to access them easily and quickly.
- The machine should be placed on a flat counter and must be placed in settings with the following temperatures:
Minimum room temperature: 5°C/41°F
Maximum room temperature: 32°C/89°F
- If the machine has been temporarily housed in settings with a room temperature of less than 0°C/32°F, please contact a service technician prior to use.
- Water pressure supply must be between 2 and 6 bar.

2) Water supply connection

In order to connect the machine up to the water mains proceed according to the indications given in the chapter about

Installation and in compliance with any local/national safety standards of the location in which the machine is being installed.

To guarantee a correct and safe functioning of the machine and to maintain an adequate performance level and a high quality of the beverages being brewed it is important that the incoming water be of a hardness greater than 9°f (90ppm, 5°d) and less than 15°f (150ppm, 8.4°d), pH should be between 6.5 and 8.5 and the quantity of chlorides be less than 50mg/l. Respecting these values allows the machine to operate at maximum efficiency. If these parameters are not present, a specific filtration device should be installed, while always adhering to the local national standards in place regarding potable water.

Then connect the inlet of the water filter/softener (if present) to the drinking water supply using one of the supplied stainless steel braided hoses. Before connecting the filter to the water pump, flush the water supply line and the filtration system in order to eliminate any residual particles which could otherwise get stuck in taps or valves thus preventing them from working properly. Connect the water supply connection of the espresso machine to the water pump outlet using one of the supplied stainless steel braided hoses. Then connect the water pump inlet to the water filter/softener outlet (if present).

WARNING
HAZARDOUS VOLTAGE!
DISCONNECT FROM
POWER SUPPLY BEFORE SERVICING

Note: The water pump is a differential pressure volumetric pump and has been designed to be used exclusively with cold water. Make sure that water is always present while the pump is operating, otherwise air can be introduced into the brew boiler causing an undesirable condition and the pump can be damaged.

3) Electrical connections

CAUTION
BEFORE MAKING ANY ELECTRICAL CONNECTIONS MAKE SURE THAT THE 2 STRAIN RELIEF CONNECTORS ARE FIRMLY SECURED TO THE BODY OF THE MACHINE IN ORDER TO PREVENT INADVERTENT STRESS ON THE POWER CABLES.

a) Power supply cord

- This is the main power supply cable that provides power to the entire espresso machine. There are different types of cable based upon the electrical requirements of the espresso machine purchased
 - 200/220VAC 1 Phase 3-core cable with 2.5/4/6/10mm² cross section or AWG 12/10/8 (for UL version), secured to espresso machine via a strain relief connector
 - 220VAC 3 Phase 4-core cable with 4 mm² cross section for versions with 1, 2, 3 and

4 groups secured to espresso machine via a strain relief connector

- 380 VAC 3 Phase 5-core cable with 2.5/6 mm² cross section for versions with 1, 2, 3 and 4 groups secured to espresso machine via a strain relief connector.

WARNING
THE MOTOR PUMP MUST BE SITUATED CLOSE TO THE MACHINE IN AN ACCESSIBLE PLACE FOR MAINTENANCE BUT NOT FOR ACCIDENTAL INTERFERENCE AND WHERE THERE IS AN OPTIMAL AIR CIRCULATION

b) Water pump motor power cord

This is the power supply for the water pump motor. The internal electronics will switch the pump motor on when needed.

- 3-core cable with 1.5 mm² cross section or 3-core AWG 16 (for UL version) secured to espresso machine via a strain relief connector.

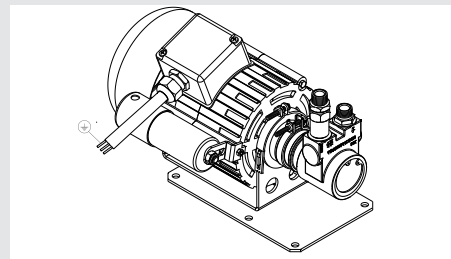

WARNING
REPLACE FUSES WITH THE SAME SIZE, TYPE AND RATING F1 = 2A, 250V

4) Waste water drain connection

The espresso machine drain is to be connected by means of the included reinforced plastic tubing. Connect one end of the reinforced plastic tubing to the drain hose connection on the left side of the espresso machine, secure with included hose clamp. Connect the other end to a suitable waste water collection system.

In case such a system is not available,

WARNING
THE MANUFACTURER DECLINES ANY RESPONSIBILITY FOR ANY EVENT LEADING TO LIABILITY SUITS WHENEVER GROUNDING HAS NOT BEEN COMPLETED ACCORDING TO CURRENT LOCAL, NATIONAL, AND INTERNATIONAL REGULATIONS AND ELECTRICAL CODES, OR OTHER ELECTRICAL PARTS HAVE BEEN CONNECTED IMPROPERLY.

WARNING
- U.S.A. AND CANADA ONLY -
DO NOT CONNECT TO A CIRCUIT OPERATING AT MORE THAN 150V TO GROUND ON EACH LEG.

drained liquids may be collected in a suitable bucket. Any necessary drain pipe extensions should be the same tubing specifications of what supplied with the machine when purchased and suitable hose clamps.

WARNING
IN ORDER TO PREVENT CRACKS OR LEAKAGE: DO NOT STORE OR INSTALL THE COFFEE MACHINE IN PLACES WHERE TEMPERATURE MAY CAUSE WATER IN BOILER OR HYDRAULIC SYSTEM TO FREEZE.

4. Machine Operation and Coffee Preparation

1) Starting the espresso machine

a) Filling the boilers with water

Once the installation procedures have been completed, it is necessary to fill the boiler tanks with water. Complete the following procedure to properly fill the boiler tanks:

- **Coffee boiler**

The water flows inside the coffee boiler directly, as soon as the water system and water filter/softener taps (if present) are opened. Since the inflow of water will compress the air in the boiler it will be necessary to remove or “bleed” the air from the coffee boiler. All air must be removed in order to completely “saturate” the coffee boiler/group assemblies. To remove the air from the boiler, “bleed the groups”, it will be necessary to remove the group cover from the top of the machine. First remove the cup tray grates from the top of the machine exposing the cup tray. Remove the screws securing the group cover and then remove it. Once removed the top of the groups will be exposed.

Loosen the bleed screws one at a time (see fig.4) to allow air to escape until water flows from below the screw head.

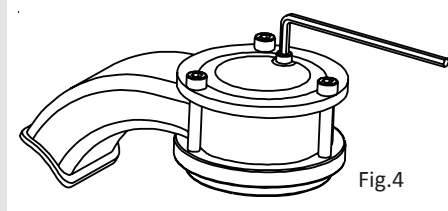

Tighten the screw to stop the water from flowing. Over tightening can cause damage to the sealing washer and the group cover. Repeat this procedure for all groups. Once all air is removed from the coffee boiler, reinstall the group cover by following the removal instructions in reverse.

- **Steam boiler**

Turn the main switch (item 1 in Fig. 1) to position “1” or ON, the automatic steam boiler level gauge will be switched on, activating the auto-fill solenoid valve and the motor pump. This will fill the steam boiler to a predetermined level and will shut off when full.

Note: It may happen that the air inside the steam boiler builds up pressure (which may be detected through the pressure gauge - item 2, fig. 1) when the water is allowed to flow in; this “false” pressure

must be eliminated by opening the steam valves (item 8, Fig. 1).

b) Turning the espresso machine on

Once you have completed these procedures, check the display. Press enter to confirm that the preceding procedures are complete.

The installation is now complete and the espresso machine should be heating to the operating temperatures.

2) Waiting for the espresso machine to heat to operating temperature

During this time, it may happen that the pointer of the coffee boiler pressure gauge reaches as high as 14-15 bar. This may happen anytime that the heating element is in the on condition. In this case it is necessary to adjust the expansion valve (Fig. 3) in such a way that the pressure may never exceed 11-12 bar. In normal operating conditions, the coffee boiler pressure gauge can read anywhere from 0-12 bar.

When brewing, the pressure should be set to 9 bar.

When the steam boiler reaches operating temperature, the light on the Tea dispense button will light.

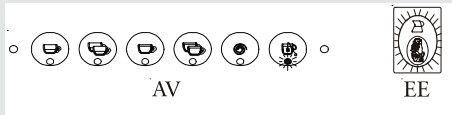

When the espresso machine is ready to operate all lights on the keypads will light.

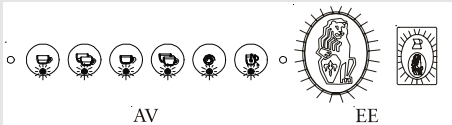

3) Brewing after first installation

Once the first installation procedures are finished, before proceeding with brewing coffee, hot water and steam, please follow these steps:

- Engage the portafilters by inserting them into each group, brew water through each group for at least two minutes.
- Being careful to avoid burns, turn on each steam wand for at least one minute.
- Turn on the hot water valve for the time necessary to allow the following quantities of water to be brewed:

At least 1 liter for a 1/2 group machine

At least 2 liters for a 3 group machine

At least 3 liters for a 4 group machine

4) Installing the portafilters

Install the portafilter(s) by inserting them into the group and rotate the handle from left to right. When the portafilters are inserted properly, you can press any of brew

buttons to start the flow of water through the portafilter. You should allow hot water to pass through the empty portafilter(s) for a few seconds each time, in order to pre-heat the portafilter.

Note: It is important to leave the portafilters installed in the espresso machine when not in use. The portafilter must remain heated for the brew process to function correctly.

5) Water pump

Whenever you are brewing coffee, you can adjust the pump pressure by turning the by-pass screw (below the plug located on the side to which the pump power supply is connected) clockwise to increase and counter-clockwise to reduce pressure. Adjust pressure only when at least one group is brewing coffee.

Note: When the heating element in the coffee boiler is energized, the water will expand increasing the start-up pressure. Once the maximum pressure is reached, the expansion (safety) valve should start working by discharging a few drops of water, in order to prevent such pressure from exceeding 11-12 bar.

In case the pressure exceeds 12 bar, you must adjust the expansion valve by unscrewing the cap slightly. If this is not sufficient, remove the valve and clear

away any calcium deposits. This remedy is valid also in case the valve remains open in the drain position (i.e. the pressure cannot increase to 8 bar approx.).

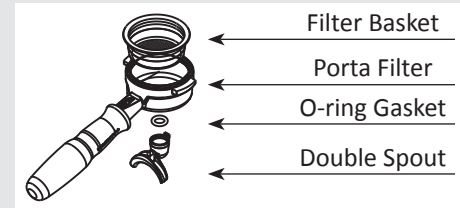

6) Brewing coffee

It is now possible to remove one of the portafilters to make an espresso beverage. Place some ground coffee in the filter itself: 1 dose (approximately 6-7 g) for the small filter, 2 doses (2 approximately 12-15 g) for the larger filter. Press down on the ground coffee with the supplied tamper and install the filter holder up again to the bottom of the group and then press a button (AV model) to begin the brewing process, or move the paddle lever (MP model see picture below).



Note: Some baristas believe it is important to press the brewing button prior to installing the portafilter to allow the water to flush any remaining coffee oils and particles from the group. Some also flush just after brewing coffee for the same reason. Please experiment to find the best possible procedure for you.

7) Controlling the brew process using volumetric programming (AV model only)

This espresso machine allows the volumetric programming of each of the first two buttons on each group (numbered left to right). Please consult the Software Programming Manual for further instructions.

8) General notes for coffee preparation

The portafilters must remain heated since they are at the lowest position of the group itself, and they are partially isolated due to the rubber gasket between them. This can be accomplished by leaving the portafilters installed in the machine when not in use. The portafilters may also be actively heated. This procedure may be carried out

by brewing some hot water through the portafilter then turning off the water flow, before making coffee.

It is important to remember that coffee left over in the filters must be removed only when you need to prepare another cup, and only at that time should you place a new dose of ground coffee in the filter.

The size of the coffee granules is extremely important in preparing a good cup of coffee, other than the type of coffee mix used, quite obviously. The ideal grinding can be determined by making various coffees using the amount of ground coffee that you would normally use for each cup (we recommend at least 6-7g). The best grinding is that which allows coffee to flow out from the filter holder spouts neither too slowly (drop by drop) nor too quickly (quick light brown flow). A general rule is that a double dose should dispense approximately 25cc or 2 fluid oz. of espresso in approximately 25 seconds.

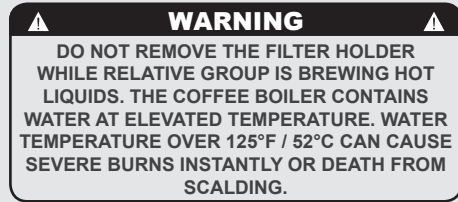

IMPORTANT

To improve the flavor of the espresso, the temperature of the water in the coffee boiler and therefore of the groups may eventually be raised or lowered via the digital display (please consult the Software Programming Manual for detailed instructions).

5. Dispensing Steam and Hot Water

1) Steaming milk or other liquids

In order to allow for any condensed water in the wand to be released ALWAYS allow some steam to be discharged by turning on the valve before inserting the steam wand into the pitcher of liquid to be heated.

Dip one of the 2 steam wands (part 8, fig. 1) which are connected to the steam valve, into the liquid to be heated, turn the steam knob (part 9, fig. 1) gradually until steam comes out at the end of the wand.

The steam will transfer heat to the liquid raising its temperature up to boiling point. Be careful not to allow liquid to overflow in order to avoid severe burns.

In order to prepare milk for making cappuccino with the right amount of foam, go through the following steps:

- Place the container half-full of milk under the steam wand, open the steam valve and heat the milk to desired temperature.

- Lower the container so as to bring the wand end to a point just below the surface of the milk; at this point, move the container up and down just enough to dip the nozzle end in and out of the milk until you get the right amount of foam. You can then pour this milk into a cup containing warm espresso and you will end up with a fresh cup of cappuccino.

In order to prevent the heated liquid from being sucked back into the steam boiler it is recommended that you purge the steam valve and steam wand by opening the valve for a few seconds to allow steam to escape to the atmosphere from the end of the steam wand. Failure to do so can cause the heated liquid to transfer from the heated liquid container to the steam boiler (via vacuum created from cooling parts). This condition is undesirable and can cause contamination in the steam boiler.

2) Preparing tea and other hot drinks

You may dispense hot water by using the fixed nozzle (item 10 fig 1). To dispense hot water, press the tea water button on the right most group.

This button commands the hot water delivery.



The volume of water delivered may be adjusted via the display (see the Software Programming Manual for further instructions). The temperature of the water dispensed may be adjusted by adjusting the mixing valve under the right side cover of the espresso machine.

6. Maintenance and Periodic Cleaning Operations

WARNING

THE MACHINE MUST BE INSTALLED SO THAT QUALIFIED TECHNICAL PERSONNEL CAN EASILY ACCESS IT FOR EVENTUAL MAINTENANCE.

CAUTION

THE MACHINE MUST NOT BE DIPPED IN NOR SPLASHED WITH WATER IN ORDER TO CLEAN IT. FOR CLEANING OPERATIONS, PLEASE FOLLOW THE INSTRUCTIONS LISTED BELOW VERY CAREFULLY.

1) Cleaning groups and drain wells

- Put a half teaspoon of detergent powder for coffee machines into the blind filter, supplied with the machine, and tighten it onto the group you want to clean by using a normal filter holder.
- Activate the automating rinsing (backflushing) routine (see the Software Programming Manual for more detailed instructions).
- Rinse the group using a normal filter, by running hot water through it several times

2) Cleaning filters and filter holders

- Put 2 or 3 teaspoons of detergent powder for coffee machines in about 1/2 a litre of water inside a heat-resistant container and heat.
- Dip filters and filter holders (but not

WARNING

NEVER REMOVE THE FILTER HOLDER WHEN WATER IS BEING DELIVERED. THIS OPERATION CAN BE EXTREMELY DANGEROUS SINCE THE HIGH PRESSURE BUILT-UP INSIDE THE BLIND FILTER WOULD SPRAY OUT HOT AND SLIGHTLY CAUSTIC WATER, WHICH MAY CAUSE SEVERE BURNS. THE COFFEE BOILER CONTAINS WATER AT ELEVATED TEMPERATURE. WATER TEMPERATURE OVER 125°F / 52°C CAN CAUSE SEVERE BURNS INSTANTLY OR DEATH FROM SCALDING.

the handles) in the heated solution and leave them fully submerged for about 30 minutes.

- Rinse thoroughly with clean water and run hot water through one group several times with the filters in place.
- Make one cup of coffee and discard in order to remove any unpleasant flavor.

3) Cleaning the drain collector

Remove the drain tray grill at least twice a week and clean, pull out the water drain collector and clean it thoroughly. Inspect and clean the drain well also, and remove any leftover grounds.

4) Cleaning the body

Wipe the stainless steel surfaces with a soft, non abrasive cloth in the direction of

the glazing marks, if any. Do not use any alcohol or solvents whatsoever on painted or imprinted parts in order not to damage them.

5) Cleaning the hot water and steam nozzles

Steam nozzles must be cleaned immediately after use with a damp cloth and by producing a short burst of steam so as to prevent the formation of deposits inside the nozzles themselves, which may alter the flavor of other drinks to be heated. Hot water nozzles must be cleaned periodically with a damp cloth.

6) Cleaning the diffuser screen

- Due to filter holder discharge operations (subsequent to coffee brewing), a certain

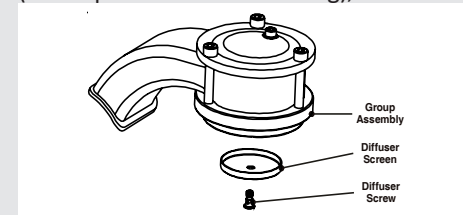

amount of coffee grounds may slowly build-up on and obstruct, even partially, the diffuser screen. To clean it, you must first remove it by unscrewing the diffuser screw.

- Put 2 or 3 teaspoons of cleaning detergent for coffee machines in about 1/2 a litre of very hot water inside a heat-resistant container.

- Place the diffuser screen(s) and diffuser screw(s) in the solution and leave them fully submerged for about 30 minutes.

WARNING
IN ORDER TO PREVENT CRACKS OR LEAKAGE: DO NOT STORE OR INSTALL THE COFFEE MACHINE IN PLACES WHERE TEMPERATURE MAY CAUSE WATER IN BOILER OR HYDRAULIC SYSTEM TO FREEZE.

7) Cleaning the gigger

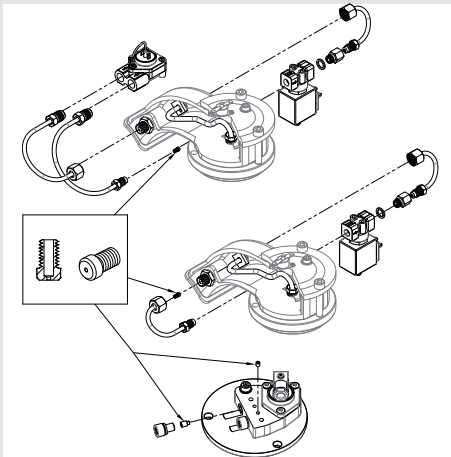

The gigger (or restrictor) on a GB5 group cap can be located under the solenoid valve. In order to access the gigger you must first turn off the water to the machine and de-pressurise the coffee boiler.

To remove the solenoid valve you will need a 4mm allen key. Loosen the two allen screws and lift off the solenoid body from the group cap. Be careful not to lose the two 'o' rings. The gigger can be removed from the hole in the group cap with a 2mm allen key.

Clean the gigger with a mild de-scaling solution and/or a fine wire (such as a guitar string)

Re-assembly is the reverse of dis-assembly.

IMPORTANT

If the machine has not been used for more than 8 hours or, in any case, after long periods of being idle, in order to use the machine to its full potential it is necessary to perform some cleaning cycles before brewing beverages as follows:

- Groups: with the portafilters engaged in the groups brew water through each for at least two minutes
- Being careful to avoid burns, turn on each steam wand for at least one minute.
- Turn on the hot water valve for the time necessary to allow the following quantities of water to be brewed:

At least 1 liter for a 1/2 group machine

At least 2 liters for a 3 group machine

At least 3 liters for a 4 group machine

If the machine is not going to be used for long periods of time, it is advisable to follow these safety instructions:

- Disconnect the machine from the water mains or interrupt the water connection via a mains tap.
- Disconnect the machine from the electrical mains.

WARNING
IF THE ABOVE-MENTIONED INSTRUCTIONS ARE NOT ADHERED TO THE MANUFACTURER CANNOT BE HELD RESPONSIBLE FOR DAMAGE TO PERSONS OR THINGS.

Whenever is necessary to store the machine for long period drain all boilers.

7. De-Commissioning and Demolition

1) De-commissioning and demolition

Start by setting the main switch to the “0” or OFF position.

Disconnecting from the power outlet

Disconnect the espresso machine from the electrical network by switching off the associated circuit breaker or circuit protection device. Remove the power supply cord from the power connection. Remove the Pump Motor Power Cord from the water pump motor.

Disconnecting from the water system

Shut off the water supply by closing the specific tap located upstream of the water filter/softener inlet. Disconnect the water pipe at the water filter/softener inlet.

Remove the hose connecting the espresso machine to the water pump. Remove the reinforced plastic tubing on the drain connection.

At this point, the machine may be removed from the bar, being very careful not to drop it.

The machine is made out of various materials and therefore, if you do not intend to put it back in service, it must be taken to a special disposal company which will select the materials which can be recycled and discard the others.

Current regulations make it illegal to discard such machine by leaving it on public grounds or on any private property.

Recycling notice: Warning for the protection of the environment.

Used Electrical and electronic waste contains hazardous but also valuable and scarce materials which should be recovered and recycled properly. We kindly ask that you contribute to the protection of the environment and natural resources by delivering used equipment

to the relevant recycling locations if such locations are available in your country.

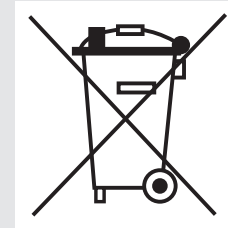

8. Mandatory Maintenance and Check-up Operations

These operations are in addition to the Maintenance and Periodic Cleaning Operations as specified in Chapter 7.

The following maintenance and check-up operations should be carried out by a qualified technician.

The time required for the periodic maintenance is determined by the quantity of daily work and/or coffee consumption.

N.B. These periodic maintenance operations are not covered by warranty.

EVERY THREE/FOUR MONTHS

- | | | | |
|--|---|--|--|
| <ul style="list-style-type: none">▪ Replace group gaskets▪ Replace diffuser screens▪ Clean auto-fill probe▪ Check vacuum breaker for proper operation▪ Inspect water inlet valve▪ Inspect drain system for leaks or clogs▪ Check flow rate for each group▪ Check brew temperature | <ul style="list-style-type: none">▪ Check that brew pressure is at 9bar▪ Check all switches for proper operation▪ Check/note water hardness (Water quality must be within the range of parameters specified in the chapter on Installation, otherwise warranty is voided)▪ Check filter basket condition | If AV Model: <ul style="list-style-type: none">▪ Check shot volumes▪ Test flowmeter's ohm value (ohm value is acceptable if greater than 1.8 K ohm, and less than 2.2 K ohm) | If MP Model: <ul style="list-style-type: none">▪ Rebuild MP valve |
|--|---|--|--|

EVERY SIX/EIGHT MONTHS (in addition to the above)

- Rebuild steam assemblies

EVERY YEAR (in addition to the above)

- | | |
|---|--|
| <ul style="list-style-type: none">▪ Replace portafilter baskets▪ Inspect group valve plungers▪ Inspect vacuum breaker▪ Inspect steam boiler pressurestat▪ Inspect contactor | <ul style="list-style-type: none">▪ Inspect expansion valve▪ Inspect electrical wiring condition▪ Inspect boilers safety switches▪ Replace over-pressure valve (safety valve) |
|---|--|

EVERY 3 YEARS (in addition to the above)

- Check the condition of the inside of boilers and if necessary rinse out with a proper cleaning product allowed for food and beverage appliances.

Description

- This espresso machine has a CPU and many configurable settings.
- Additionally, there are many feedback controls employed in this espresso machine to troubleshoot problems should they occur.
- The following is a brief introduction to the controls and display and how they interact with the operator.

Digital Display





The digital display (display) is a backlit display capable of displaying 2 lines of 16 characters. The display enables the operator to interact with the espresso machine to visibly change parameter values. The display also provides valuable information to the operator. There are several warnings that can be displayed to alert the operator of an unusual condition or a fault. Additionally, simple messages are displayed alerting the operator that an action has been started or that a process needs to begin.

Programming Keypad





The programming keypad is always located as the group 1 controls (left most keypad). These are the buttons used to change values within the configurable parameters.

The  and the  buttons are used to change the values of the individual parameters.

The  button is used to scroll through the parameters. Additionally, this button also confirms values within the parameters.

The  button confirms the values within the parameters. Additionally it is also used to scroll through the values within the parameters.

The  button is used to access the programming mode.

The  button is used to turn on and turn off the espresso machine. This button can also be used to exit the programming mode.

Programming Mode



Description

- To change any configurable parameter the operator must first enter into the programming mode.
- There are several levels within the programming mode that allow the restriction of specific parameters depending upon the password entered.

Accessing Programming Mode

The three programming levels are as follows:

- **Barista Programming** - No password necessary. Limited parameters are available.
- **Technical Programming** - Technica password needed. Barista level parameters plus additional parameters are available.
- **Roaster Programming** - Roaster password needed. A specific set of parameters are made available only to those entering this password.

Display	Operating Procedure
	1 Press and hold the button on the group 1 keypad. After approximately 5 seconds the following display appears.
	2 This is the Barista Level. Press the button to scroll through the available parameters.
	3 When finished, press to exit programming mode.
	4 Press and hold the button on the group 1 keypad. After approximately 10 seconds the following display appears.
	5 Using a combination of the following buttons (the first 5 buttons on the group 1 keypad) enter the appropriate 5 digit password.
	6 The parameters available after entering the password are dependant upon the password entered. If a technician password is entered then the technician level parameters will be made available....etc. Press to scroll through the available parameters.
	7 When finished, press to exit programming mode.



Initial Installation

Initial Installation

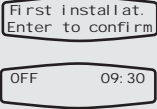

Description

- This is the initial display shown when first installing this espresso machine.
- **Note:** If machine has been bench tested by your local distributor you will not see this first display.

Display	Operating Procedure
	<ol style="list-style-type: none"> <li data-bbox="349 663 1333 711">1 Press the  button on the group 1 keypad to confirm that this is the initial installation of this espresso machine. <li data-bbox="349 734 1118 760">2 Please refer to the section "Turning the Espresso Machine On" to continue







Turning the Espresso Machine On

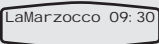
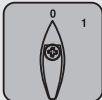
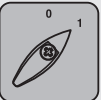

Description

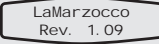
- The following is the procedure for turning on the power to the espresso machine.
- Please follow the procedures carefully to avoid any damage to the espresso machine.

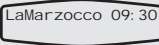
NOTE: If the message “First Installat. Enter to confirm” appears in the display, please see the preceding page entitled “Initial installation”.

Display	Operating Procedure
	<p>1 The following is the procedure for turning on the power to the espresso machine. Turn the Main Switch to the On position.</p> <div style="display: flex; justify-content: center; gap: 20px;">     </div>
	<p>2 The message at left will be displayed briefly. This message indicates the revision level of the software installed in this espresso machine.</p>
	<p>3 To complete the turn on process, press the  button and the display at left is shown. The machine begins to automatically fill the steam boiler until full. The display is asking if you have completed the coffee boiler air bleeding process (of the coffee boiler). When this process is complete, press the enter button. If the screen does not change, wait until the steam boiler is completely full and try again.</p>
	<p>4 The espresso machine is now ON and you should see one of the two following displays.</p>
	<p>5 When the espresso machine reaches operating temperature the lights on all keypads will light indicating that the espresso machine is ready to use.</p>

⚠ WARNING ⚠
HAZARDOUS VOLTAGE DISCONNECT FROM POWER SUPPLY BEFORE SERVICING

Shut Down Procedures









Turning the Espresso Machine Off

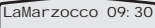
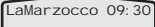

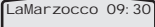
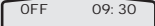
Description

- The following is the procedure for turning off power to the espresso machine.
- Please follow the procedures carefully to avoid any damage to the espresso machine.

- This machine has two off settings:
 - One setting turns off all of the components in the espresso machine.
 - The other turns off power to the complete espresso machine.

Display	Operating Procedure
	<p>1 The following is the procedure for safely turning off the espresso machine.</p>
	<p>2 Press and hold the  button (approximately 3 seconds). The display changes to the following:</p>
	<p>3 This is the OFF setting used in the normal operating conditions.</p>
	<p>4 During servicing or other conditions that warrant it the main switch should be turned to the OFF or “0” position.</p>
	<div style="display: flex; justify-content: center; gap: 20px;">     </div>
	<p>5 The espresso machine is off and display should be blank. It is important to follow this procedure when turning off the machine. Failure to do so can damage the electronics.</p>

⚠ WARNING ⚠
HAZARDOUS VOLTAGE DISCONNECT FROM POWER SUPPLY BEFORE SERVICING







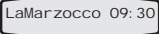

“Barista” Programming

Water Volume Programming

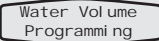

Description

- This parameter allows the operator to program the water volume (shot volume) for the individual buttons on the keypad.
- The saved program is a number. This number relates to the number of pulses the flowmeter delivers to the CPU. Once the programmed number of pulses is received by the CPU, the flow of water is stopped.

Display	Operating Procedure
	<p>1 Press and hold the  button on the group 1 keypad until the following is displayed (approximately 5 seconds):</p>
	<p>2 Press the  button on the group 1 keypad again. The lights on the first 4 buttons will light and the light on the continuous button will begin flashing. The flashing light indicates the keypad is in programming mode</p> <p>3 While in programming mode, press any of the first 4 buttons. When the desired amount of water has been dispensed, press the same button again to stop the flow of water. Continue this same procedure for all buttons that programming is desired.</p> <p>4 Once the first 4 buttons are programmed, press the  button to exit programming mode</p> <p>5 To program the tea water dispense button, repeat procedure 1 then press the  button on the corresponding keypad that you wish to program. When the light begins to flash, press  the button. When the desired amount of water has been dispensed, press the  button again to stop the flow of water. When finished  press the button to exit programming mode.</p> <p>NOTE: The programming completed for group 1 keypad will be copied to all subsequent keypads. If other programming is desired for subsequent keypads, follow procedure 1 and 2 substituting the subsequent group keypad number for procedure 2. It is recommended to program each group separately.</p>

“Barista” Programming

Nominal Coffee Boiler Temperature



Description

- This parameter is set at the factory at a preset nominal temperature.
- The set temperature of this parameter differs from the actual temperature of the water exiting the group to the coffee.
- The temperature of the boiler is measured at the most critical point in the boiler when temperature fluctuation is the greatest.

- The temperature of the water exiting the group head is held constant by means of the mass of the group casting. Even though the temperature of the boiler may vary a few degrees, the temperature of the water exiting the group is constant.
- To set the temperature of any espresso machine it is important to measure the temperature of the water exiting the group.









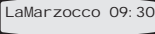

Display	Operating Procedure
	1 Press and hold the button on the group 1 keypad until the following is displayed (approximately 5 seconds):
	2 Press the button on the group 1 keypad until the following appears (one time):
	3 Press the button to select the coffee boiler you wish to change temperature.
	4 Press the or the button to change the temperature on the displayed boiler. The measured temperature appears on the left and the set temperature appears on the right side of the display. Once the desired temperature is selected press the button to confirm the selection.
	5 Repeat procedure 5 for all subsequent boilers (if installed).
	6 When finished, continue to the next parameter or press to exit programming mode.

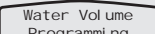
Cup Heating

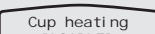

Description

- This parameter allows the user to enable or disable the cup heating routine.
- The cup heater is an option ordered from the factory, not available in the USA & Canada.
- Additional parameter settings are available in the factory level parameters under Cup Heating Times.

Display	Operating Procedure
	1 Press and hold the  button on the group 1 keypad until the following is displayed (approximately 5 seconds):
	2 Press the  button on the group 1 keypad until the following appears (two times):
	3 Press the  or the  button to change to ENABLED or DI SABLED. Once the desired condition is displayed press the  button to confirm.
	4 When finished, continue to the next parameter  or press  to exit programming mode.







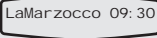

“Barista” Programming

Doses Reading

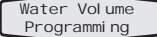

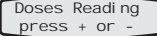
Description

- This parameter allows the user to review the total doses dispensed for each button.
- The number displayed is the total number of times the individual button has been activated.









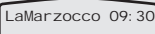

Display	Operating Procedure
	1 Press and hold the  button on the group 1 keypad until the following is displayed (approximately 5 seconds):
	2 Press the  button on the group 1 keypad until the following appears (three times):
	3 Press the  or the  button to scroll through the values for each button.
	4 When finished, continue to the next parameter  or press  to exit programming mode.

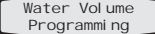
Clock Adjust

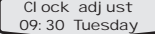

Description

- This parameter allows the user to set the time of day and the day of the week.
- This parameter is used by the “Auto On/Off” parameter

Display	Operating Procedure
	<p>1 Press and hold the  button on the group 1 keypad until the following is displayed (approximately 5 seconds):</p>
	<p>2 Press the  button on the group 1 keypad until the following appears (four times)</p>
	<p>3 The hour value should be flashing. Press the  or the  button to change the hour.</p>
	<p>4 Press the  button to change to minute value and again to change to the day of the week value. Follow step 3 to change these values.</p>
	<p>5 When finished, continue to the next parameter  or press  to exit programming mode.</p>











“Barista” Programming

Auto On/Off



Description

- This parameter allows the user to program the espresso machine to turn on at a preset time and turn off at a preset time.
- This feature also allows the espresso machine to remain in the off condition for one repeating closed day.

Display	Operating Procedure
LaMarzocco 09:30	1 Press and hold the  button on the group 1 keypad until the following is displayed (approximately 5 seconds):
Water Volume Programming	2 Press the  button on the group 1 keypad until the following appears (five times):
Auto On/Off On: --:--	3 The hour value should be flashing. Press the  or the  button to change the hour for the “On” time.
Auto On/Off Off: --:--	4 Press the  button to change to the minute value. Follow step 3 to change this value.
Auto On/Off Off: --:--	5 Press the  button again to change to hour value for the “Off” time. Follow step 3 to change this value.
Auto On/Off Off: --:--	6 Press the  button again to change to minute value for the “Off” time. Follow step 3 to change this value.
Closed On -----	7 Press the  button again to change to the “Closed On” value. Follow step 3 to change this value
	8 When finished, continue to the next parameter  or press  to exit programming mode.







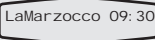

“Technical” Programming

Language

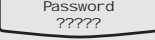
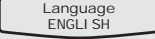

Description

- This parameter allows the technician to change the language of the display.

Display	Operating Procedure
	<p>1 Press and hold the  button on the group 1 keypad until the following is displayed (approximately 10 seconds):</p>
	<p>2 Enter the 5 digit technician password using buttons 1-5 on the group 1 keypad. Once accepted the following appears:</p>
	<p>3 Press the  or the  button to change the display language. You may choose from Italian, Francaise, English or Deutsch. Once the desired selection is made press the  button to confirm the selection.</p>
	<p>4 When finished, continue to the next parameter  or press  to exit programming mode.</p>





“Technical” Programming

Total Doses



Description

- This parameter keeps a count of each dose that is produced with this espresso machine.
- This number can be an important reference when troubleshooting the espresso machine.
- This number cannot be adjusted nor reset.









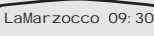

Display	Operating Procedure
LaMarzocco 09:30	1 Press and hold the  button on the group 1 keypad until the following is displayed (approximately 10 seconds)
Password ?????	2 Enter the 5 digit technician password using buttons 1-5 on the group 1 keypad. Once accepted the following appears:
Language ENGLISH	3 Press the  button on the group 1 keypad until the following appears (about three times):
Total Doses 15	4 The number displayed is the total number of doses that this machine has produced
	5 When finished, continue to the next parameter  or press  to exit programming mode.

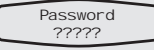
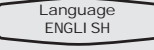
Cronos Function (shot timer)

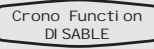

Description

- When enabled, this parameter displays a timer that times each shot.
- The corresponding timer is reset each time a button on the corresponding keypad is pressed
- When enabled, the Cronos Function is continuously displayed. User name will not be displayed when this parameter is enabled.

Display	Operating Procedure
	1 Press and hold the  button on the group 1 keypad until the following is displayed (approximately 10 seconds)
	2 Enter the 5 digit technician password using buttons 1-5 on the group 1 keypad. Once accepted the following appears:
	3 Press the  button on the group 1 keypad until the following appears (about four times):
	4 Press the  or the  button to change to ENABLED or DI SABLED. Once the desired condition is displayed press the  button to confirm
	5 When finished, continue to the next parameter  or press  to exit programming mode. NOTE: When this parameter is ENABLED the display will be changed to the following (3 group version shown here): <div style="text-align: center; margin-top: 20px;">  </div>









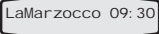

“Technical” Programming

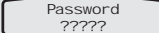
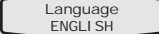
User Name

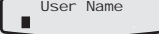

Description

- This parameter allows the technician to program a 16 character user name.
- The user name is displayed continuously on the display on the second line.
- The user name is not displayed when the Cronos Function is ENABLED.











Display	Operating Procedure
	1 Press and hold the  button on the group 1 keypad until the following is displayed (approximately 10 seconds)
	2 Enter the 5 digit technician password using buttons 1-5 on the group 1 keypad. Once accepted the following appears:
	3 Press the  button on the group 1 keypad until the following appears (about five times):
	4 The first character in the user name is flashing. Press the  or the  button to change the value. Once the desired condition is displayed press the  button to advance to the next.
	5 When finished, continue to the next parameter  or press  to exit programming mode. The following is a listing of the available characters: ABCDEFGHI JKLMNOPQRSTUVWXYZO123456789():. , , *+, -. /! , , #&=?@ (BLACK SPACE)

Pre-Brewing (Pre-Infusion)



Description

- This parameter allows the technician to enable or disable the pre-brewing (also called pre-infusion) function.
- Pre-brewing has two values to adjust. T(tot) is the total time for pre-brewing. T(on) is the amount of time that the brew valve is open during T(tot). The off time is calculated by subtracting T(on) from T(tot).

Display	Operating Procedure
LaMarzocco 09:30	1 Press and hold the  button on the group 1 keypad until the following is displayed (approximately 10 seconds)
Password ?????	2 Enter the 5 digit technician password using buttons 1-5 on the group 1 keypad. Once accepted the following appears:
Language ENGLISH	3 Press the  button on the group 1 keypad until the following appears (about six times):
Pre-Brewing DI SABLED	4 Press the  or the  button to change to ENABLED or DI SABLED. Once the desired condition is displayed press the  button to confirm.
Key 1 Group 1 Ttot: 20 Ton: 10	5 If ENABLED is chosen, the display then shows the values for T(tot) and T(on) for each button. Press  or the  to adjust a value and press  to advance to the next value.
	6 Repeat procedure 5 for each button (key) that you wish to activate pre-brewing. A setting of T(tot) = 0 and T(on) = 0 disables pre-brewing on the individual button.
	7 When finished, continue to the next parameter  or press  to exit programming mode.
	NOTE: The unit of measure for these values is 1/10 sec. Therefore a value of 10 equals 1 second.















“Technical” Programming

Filter Alarm



Description

- This parameter allows the technician to preprogram an alarm that notifies the user when the water filter requires service or replacement.
- When the programmed volume of water has passed through the espresso machine the error message “Change Filter” is displayed.
- A value of 0 (zero) disables the filter alarm parameter.

Display	Operating Procedure
LaMarzocco 09: 30	1 Press and hold the  button on the group 1 keypad until the following is displayed (approximately 10 seconds)
Password ?????	2 Enter the 5 digit technician password using buttons 1-5 on the group 1 keypad. Once accepted the following appears:
Language ENGLISH	3 Press the  button on the group 1 keypad until the following appears (about seven times):
Filter Alarm	4 Press the  button on the group 1 keypad until the following appears (about six times):
Change H2O Filtr. 0 liters	5 Press the  or the  button to change the volume of water required before filter servicing/replacing is recommended. When finished press  to confirm.
Water Flow 12 cc/sec	6 Press the  or the  button to change the estimated flow rate of water. Normally this value should not be changed. When the desired value is displayed press  to confirm.
	7 When finished, continue to the next parameter  or press  to exit programming mode.
	Note: To reset the function turn off the machine with the  button (press and hold approximately 3 seconds). Next, press and hold the  button while turning on using the  button.







“Technical” Programming

Steam Boiler Automatic Fill



Description

- This parameter allows the technician to select the activation of the water pump during the steam boiler auto-fill cycle.
- Only under unusual circumstances would the option of “without pump” be chosen.
- The electronics installed in this espresso machine give priority to the brew boiler for pressure. The activation of the auto-fill cycle during the brewing process can reduce the overall dispensing pressure in the brew boiler.
- During the auto-fill cycle, if a brew cycle is chosen, the auto-fill cycle is delayed until all brew cycles are complete.

Display	Operating Procedure
LaMarzocco 09:30	1 Press and hold the  button on the group 1 keypad until the following is displayed (approximately 10 seconds)
Password ?????	2 Enter the 5 digit technician password using buttons 1-5 on the group 1 keypad. Once accepted the following appears:
Language ENGLISH	3 Press the  button on the group 1 keypad until the following appears (about eight times):
Filling-up with pump	4 Press the  or the  button to change to with pump or without pump. Once the desired condition is displayed press the  to confirm.
	5 When finished, continue to the next parameter  or press  to exit programming mode.









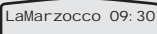

“Technical” Programming

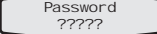
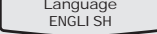
Steam Boiler Automatic Fill During Coffee Dispensing



Description

- This parameter allows the technician to Enable/Disable the steam boiler automatic filling while dispensing coffee.







Display	Operating Procedure
	<p>1 Press and hold the  button on the group 1 keypad until the following is displayed (approximately 10 seconds)</p>
	<p>2 Enter the 5 digit technician password using buttons 1-5 on the group 1 keypad. Once accepted the following appears:</p>
	<p>3 Press the  button on the group 1 keypad until the following appears (about nine times):</p>
	<p>4 Press the  or the  button to change to ENABLE or DISABLE. Once the desired condition is displayed press the  button to confirm.</p> <p>5 When finished, continue to the next parameter  or press  to exit programming mode.</p>

Tea Water



Description

- This parameter allows the technician to select the activation of the water pump during hot water dispensing.
- When hot water is drawn from only the steam boiler this parameter should be set to “without pump”.
- If the optional adjustable temperature hot water dispense valve is installed, this parameter is set to “with pump”.

Display	Operating Procedure
LaMarzocco 09:30	1 Press and hold the  button on the group 1 keypad until the following is displayed (approximately 10 seconds)
Password ?????	2 Enter the 5 digit technician password using buttons 1-5 on the group 1 keypad. Once accepted the following appears:
Language ENGLISH	3 Press the  button on the group 1 keypad until the following appears (about ten times):
Tea water without pump	4 Press the  or the  button to change to with pump or without pump. Once the desired condition is displayed press the  button to confirm.
	5 When finished, continue to the next parameter  or press  to exit programming mode.

“Technical” Programming

Steam Boiler Pressure Regulation



Description

- This espresso machine comes with the option of either a pressure switch or a temperature probe for maintaining pressure in the steam boiler.
- The temperature probe is standard on all espresso machines. In some cases a pressure switch may be used.
- The pressure switch regulates pressure via a diaphragm type pressure switch.

The pressure may be adjusted via a small screw on the switch.

- When a temperature probe has been installed the pressure in the steam boiler is regulated by adjusting the temperature of the steam boiler via the display.
- Since the temperature of saturated water is proportional to the pressure it is possible to control the pressure of the steam boiler via a temperature probe.

Display	Operating Procedure
	1 Press and hold the button on the group 1 keypad until the following is displayed (approximately 10 seconds)
	2 Enter the 5 digit technician password using buttons 1-5 on the group 1 keypad. Once accepted the following appears:
	3 Press the button on the group 1 keypad until the following appears (about eleven times):
	4 Press the or the button to change the value to Pressure-switch or Temp. Probe then press to confirm selection. Normally this value should not be changed
	5 When finished, continue to the next parameter or press to exit programming mode.
	<p>NOTE: When this parameter is set to “Temp. Probe” an additional parameter named “Steam Temp. Cor. is activated. When changing from Temp Probe to Pressure Switch it is required to cycle power off and on through the main switch to reset the steam boiler over temperature alarm.</p>

“Technical” Programming

Steam Boiler Temperature Correction



Description

- This parameter allows the technician to adjust the pressure of the steam boiler by raising or lowering the temperature of the steam boiler.
- This parameter is only active when the parameter “Steam heat.Type” is set to “Temp Probe”.

Display	Operating Procedure
	1 Press and hold the button on the group 1 keypad until the following is displayed (approximately 10 seconds)
	2 Enter the 5 digit technician password using buttons 1-5 on the group 1 keypad. Once accepted the following appears:
	3 Press the button on the group 1 keypad until the following appears (about twelve times):
	4 Press the or the button to adjust the temperature higher or lower. Each block is equal to 32.9°F (0.5°C). Once the desired setting is made press the button to confirm the setting. 5 When finished, continue to the next parameter or press to exit programming mode.
<div style="border: 2px solid black; padding: 5px; background-color: black; color: white;"> ⚠ <h2 style="margin: 0;">CAUTION</h2> ⚠ <p style="font-size: small; margin: 5px 0;">The saturation temperature of water will vary with ambient atmospheric pressure. Tables in this manual are created for atmospheric pressure at sea level. Slight adjustment in temperature will be required for elevations other than sea level.</p> </div>	
<div style="border: 2px solid black; padding: 5px; background-color: black; color: white;"> ⚠ <h2 style="margin: 0;">DANGER</h2> ⚠ <p style="font-size: small; margin: 5px 0;">THE STEAM BOILER CONTAINS WATER AT ELEVATED TEMPERATURES. WATER TEMPERATURE OVER 125°C CAN CAUSE SEVERE BURNS INSTANTLY OR DEATH FROM SCALDING.</p> </div>	







“Technical” Programming

Technician Password Assignment



Description

- This parameter allows the technician to change the password necessary to access the Technician Level Parameters (please make a note of the password as it is not resettable)

Display	Operating Procedure
LaMarzocco 09:30	1 Press and hold the  button on the group 1 keypad until the following is displayed (approximately 10 seconds)
Password ?????	2 Enter the 5 digit technician password using buttons 1-5 on the group 1 keypad. Once accepted the following appears:
Language ENGLISH	3 Press the  button on the group 1 keypad until the following appears (about thirteen times):
Password Setting	4 Press the  button and you will be prompted to enter the new password. Enter a new 5 digit password using a combination of the first 5 buttons on the group 1 keypad <div style="text-align: center; margin: 10px 0;">  </div> 5 When finished, continue to the next parameter  or press  to exit programming mode.





“Technical” Programming

Water Volume Programming



Description

- This parameter allows the operator to program the water volume (shot volume) for the individual buttons on the keypad.
- The saved program is a number. This number relates to the number of pulses the flowmeter delivers to the CPU. Once the programmed number of pulses is received by the CPU, the flow of water is stopped.

Display	Operating Procedure
LaMarzocco 09:30	1 Press and hold the  button on the group 1 keypad until the following is displayed (approximately 10 seconds)
Password ?????	2 Enter the 5 digit technician password using buttons 1-5 on the group 1 keypad. Once accepted the following appears:
Language ENGLISH	3 Press the  button on the group 1 keypad until the following appears (about fourteen times):
Water Volume Programming	4 Press the  button on the group 1 keypad again. The lights on the first 4 buttons will light and the light on the continuous button will begin flashing. The flashing light indicates the keypad is in programming mode
	5 While in programming mode, press any of the first 4 buttons. When the desired amount of water has been dispensed, press the same button again to stop the flow of water. Continue this same procedure for all buttons that programming is desired. Once the first 4 buttons are programmed, press the  button to exit programming mode







“Technical” Programming

Water Volume Programming



Description

- This parameter allows the operator to program the water volume (shot volume) for the individual buttons on the keypad.
- The saved program is a number. This number relates to the number of pulses the flowmeter delivers to the CPU. Once the programmed number of pulses is received by the CPU, the flow of water is stopped.

Display	Operating Procedure
	<p>6 To program the tea water dispense button, repeat procedure 1 then press the  button on the corresponding keypad that you wish to program. When the light begins to flash, press  the button. When the desired amount of water has been dispensed, press the  button again to stop the flow of water. When finished  press the button to exit programming mode.</p> <p>7 When finished, continue to the next parameter  or press  to exit programming mode.</p> <p>NOTE: The programming completed for group 1 keypad will be copied to all subsequent keypads. If other programming is desired for subsequent keypads, follow procedure 1 and 2 substituting the subsequent group keypad number for procedure 2. It is recommended to program each group separately.</p>

“Technical” Programming









Nominal Coffee Boiler Temperature



Description

- This parameter is set at the factory at a preset nominal temperature.
- The set temperature of this parameter differs from the actual temperature of the water exiting the group to the coffee.
- The temperature of the boiler is measured at the most critical point in the boiler when temperature fluctuation is the greatest.

- The temperature of the water exiting the group head is held constant by means of the mass of the group casting. Even though the temperature of the boiler may vary a few degrees, the temperature of the water exiting the group is constant.
- To set the temperature of any espresso machine it is important to measure the temperature of the water exiting the group.

Display	Operating Procedure
LaMarzocco 09:30	<ol style="list-style-type: none"> 1 Press and hold the  button on the group 1 keypad until the following is displayed (approximately 10 seconds): 2 Enter the 5 digit factory password using buttons 1-5 on the group 1 keypad. Once accepted the following appears: 3 Press the  button on the group 1 keypad until the following appears (about fifteen times): 4 Press the  button to select the coffee boiler you wish to change temperature. 5 Press the  or the  button to change the temperature on the displayed boiler. The measured temperature appears on the left and the set temperature appears on the right side of the display. Once the desired temperature is selected press the button  to confirm the selection. 6 Repeat procedure 5 for all subsequent boilers (if installed). 7 When finished, continue to the next parameter  or press  to exit programming mode.
Password ?????	
Groups Number 3	
Coffee Boilers Temperatures	
Coffee Boiler 1 202.5°F 202.6°F	









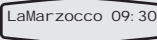

“Technical” Programming

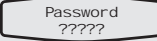
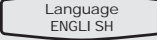
Cup Heating

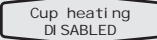

Description

- This parameter allows the user to enable or disable the cup heating routine.
- The cup heater is an option ordered from the factory, not available in the USA & Canada.
- Additional parameter settings are available in the factory level parameters under Cup Heating Times.

Display	Operating Procedure
	1 Press and hold the  button on the group 1 keypad until the following is displayed (approximately 10 seconds)
	2 Enter the 5 digit technician password using buttons 1-5 on the group 1 keypad. Once accepted the following appears:
	3 Press the  button on the group 1 keypad until the following appears (about sixteen times):
	4 Press the  or the  button to change to ENABLED or DI SABLED. Once the desired condition is displayed press the  button to confirm. 5 When finished, continue to the next parameter  or press  to exit programming mode.







“Technical” Programming

Doses Reading



Description

- This parameter allows the user to review the total doses dispensed for each button.
- The number displayed is the total number of times the individual button has been activated.

Display	Operating Procedure
LaMarzocco 09:30	1 Press and hold the  button on the group 1 keypad until the following is displayed (approximately 10 seconds)
Password ?????	2 Enter the 5 digit technician password using buttons 1-5 on the group 1 keypad. Once accepted the following appears:
Language ENGLISH	3 Press the  button on the group 1 keypad until the following appears (about seventeen times):
Doses Reading press + or -	4 Press the  or the  button to scroll through the values for each button.
	5 When finished, continue to the next parameter  or press  to exit programming mode.







“Technical” Programming

Clock Adjust



Description

- This parameter allows the user to set the time of day and the day of the week.
- This parameter is used by the “Auto On/Off” parameter







Display	Operating Procedure
	1 Press and hold the  button on the group 1 keypad until the following is displayed (approximately 10 seconds)
	2 Enter the 5 digit technician password using buttons 1-5 on the group 1 keypad. Once accepted the following appears:
	3 Press the  button on the group 1 keypad until the following appears (about eighteen times):
	4 The hour value should be flashing. Press the  or the  button to change the hour.
	5 Press the  button to change to minute value and again to change to the day of the week value. Follow step 3 to change these values.
	6 When finished, continue to the next parameter  or press  to exit programming mode.

Auto On/Off



Description

- This parameter allows the user to program the espresso machine to turn on at a preset time and turn off at a preset time.
- This feature also allows the espresso machine to remain in the off condition for one repeating closed day.

Display	Operating Procedure
LaMarzocco 09:30	1 Press and hold the  button on the group 1 keypad until the following is displayed (approximately 10 seconds)
Password ????	2 Enter the 5 digit technician password using buttons 1-5 on the group 1 keypad. Once accepted the following appears:
Language ENGLISH	3 Press the  button on the group 1 keypad until the following appears (about nineteen times):
Auto On/Off On: --. --	4 The hour value should be flashing. Press the  or the  button to change the hour for the “On” time.
	5 Press the  button to change to the minute value. Follow step 3 to change this value.
Auto On/Off Off: --. --	6 Press the  button again to change to hour value for the “Off” time. Follow step 3 to change this value.
	7 Press the  button again to change to minute value for the “Off” time. Follow step 3 to change this value.





“Technical” Programming

Auto On/Off

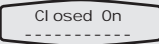

Description

- This parameter allows the user to program the espresso machine to turn on at a preset time and turn off at a preset time.
- This feature also allows the espresso machine to remain in the off condition for one repeating closed day.

Display	Operating Procedure
	<p>8 Press the  button again to change to the “Closed On” value. Follow step 3 to change this value</p> <p>9 When finished, continue to the next parameter  or press  to exit programming mode.</p>











“Roaster” Programming

Coffee Credit



Description

- This parameter allows the coffee roaster to use coffee credits as a method of purchase.
- This parameter has two settings; ENABLED or DISABLED.
- When enabled an additional parameter named “CoffeeCred.Stock” is enabled. This additional parameter allows the coffee roaster to enter a specific amount of credit to the operator.
- When the coffee credit is zero the error “Coffee Credit Exhausted” is displayed and the keypad functions are disabled.

Display	Operating Procedure
LaMarzocco 09:30	1 Press and hold the  button on the group 1 keypad until the following is displayed (approximately 10 seconds)
Password ?????	2 Enter the 5 digit roaster password using buttons 1-5 on the group 1 keypad. Once accepted the following appears:
Coffee Credit DI SABLED	3 Press the  or the  button to change to ENABLED or DI SABLED. Once the desired condition is displayed press the  button to confirm.
	4 If ENABLED is selected, press the  button to access the following setting
CoffeeCred.Stock 0	5 Press the  or the  button to change the value. Once the desired value is displayed press the button  to confirm.
	6 When finished, continue to the next parameter  or press  to exit programming mode.







“Roaster” Programming

Coffee Counter



Description

- This parameter allows the coffee roaster to monitor the amount of coffee credits used by the operator.
- This parameter is resettable.
- This parameter should be reset when new credits are input. If only additional credits are input, the value can remain.

Display	Operating Procedure
LaMarzocco 09:30	1 Press and hold the  button on the group 1 keypad until the following is displayed (approximately 10 seconds)
Password ?????	2 Enter the 5 digit roaster password using buttons 1-5 on the group 1 keypad. Once accepted the following appears:
Coffee Credit DI SABLED	3 Press the  button on the group 1 keypad until the following appears (one time):
Coffee Counter 0	4 Press the  button to reset the value.
Coffee Counter RESET ???	5 Press the  button to confirm that reset is required.
Coffee Counter Zero ser !	6 Once confirmed, the value will be set to zero.
Coffee Counter 0	7 When finished, continue to the next parameter  or press  to exit programming mode.





“Roaster” Programming

Cumulative Total



Description

- This parameter allows the coffee roaster to monitor the total amount of coffee credits used by the operator.
- This parameter is not resettable.

Display	Operating Procedure
LaMarzocco 09:30	1 Press and hold the  button on the group 1 keypad until the following is displayed (approximately 10 seconds)
Password ?????	2 Enter the 5 digit roaster password using buttons 1-5 on the group 1 keypad. Once accepted the following appears:
Coffee Credit DI SABLED	3 Press the  button on the group 1 keypad until the following appears (three times):
Cumulative Total 0	4 When finished, continue to the next parameter  or press  to exit programming mode.







“Roaster” Programming

Coffee Credit Warning Threshold



Description

- This parameter allows the coffee roaster to input a number to warn the operator that there is only a certain amount of credit available. Once the coffee credit is less than or equal to the Warning Threshold the error “Coffee Credit Outrunning” is displayed until additional credit is input

Display	Operating Procedure
LaMarzocco 09:30	1 Press and hold the  button on the group 1 keypad until the following is displayed (approximately 10 seconds)
Password ?????	2 Enter the 5 digit roaster password using buttons 1-5 on the group 1 keypad. Once accepted the following appears:
Coffee Credit DISABLED	3 Press the  button on the group 1 keypad until the following appears (three times):
WarningThreshold 0 Coffee	4 Press the  or the  button to change the value. Once the desired value is displayed press the  button to confirm. 5 When finished, continue to the next parameter  or press  to exit programming mode.

“Roaster” Programming

Individual Button Price Programming











Description

- This parameter allows the coffee roaster to use coffee credits as a method of purchase.
- This parameter has two settings; ENABLED or DISABLED.
- When enabled an additional parameter named “CoffeeCred.Stock” is enabled. This additional parameter allows to

coffee roaster to enter a specific amount of credit to the operator.

- When the coffee credit is zero the error “Coffee Credit Exhausted” is displayed and the keypad functions are disabled.

Display	Operating Procedure
LaMarzocco 09:30	1 Press and hold the  button on the group 1 keypad until the following is displayed (approximately 10 seconds)
Password ?????	2 Enter the 5 digit roaster password using buttons 1-5 on the group 1 keypad. Once accepted the following appears:
Coffee Credit DISABLED	3 Press the  button on the group 1 keypad until the following appears (four times):
Key Price Programming	4 Press the  button to access the settings in this parameter.
Key 1 Group 1 OFF Coffee	5 Press the  or the  button to change the value. Once the desired value is displayed press the  button to confirm and to advance to the next button (key)
	6 When finished, continue to the next parameter  or press  to exit programming mode.





“Roaster” Programming

Coffee Roaster Password Assignment

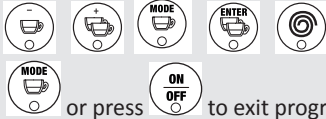

Description

- This parameter allows the coffee roaster to change the password necessary to access the roaster Level Parameters (please make a note of the password as it is not resettable)

Display	Operating Procedure
LaMarzocco 09:30	1 Press and hold the  button on the group 1 keypad until the following is displayed (approximately 10 seconds)
Password ?????	2 Enter the 5 digit roaster password using buttons 1-5 on the group 1 keypad. Once accepted the following appears:
Coffee Credit DISABLED	3 Press the  button on the group 1 keypad until the following appears (five times):
Password Setting	4 Press the  button and you will be prompted to enter the new password. Enter a new 5 digit password using a combination of the first 5 buttons on the group 1 keypad.
	<div style="text-align: center;">  </div> 5 When finished, continue to the next parameter  or press  to exit programming mode.



Extra Programs [Rinsing or Back Flushing]

Pre-Programmed Rinsing (Back Flushing) Routine



Description

- This espresso machine has a group rinsing (backflushing) routine built into the electronics.
- The rinsing routine is provided to give the operator more flexibility and freedom surrounding this operation.

Display	Operating Procedure
<div data-bbox="176 651 331 690" style="border: 1px solid black; padding: 2px; text-align: center;"> Rinsing in-progress </div>	<div data-bbox="349 658 1587 809"> <p>1 To activate the rinsing routine, press and hold the  button, then press the  button. This activates the rinsing routine on the individual group.</p> <p>2 When activated, the water pump will turn on and the electric valve, for the specific group being rinsed, will cycle on and off. There are approximately 30 cycles preprogrammed at a 4 second interval. To stop the rinsing manually, press the  button.</p> </div> <p>NOTE: To properly rinse the groups, place a small amount of cleaning detergent in a Blind portafilter basket and insert into the group to be rinsed prior to activating the rinsing routine.</p> <div data-bbox="432 954 1543 1125" style="border: 2px solid black; padding: 10px; text-align: center;"> <p>CAUTION</p> <p>Most detergents cause foaming during the cleaning process. This foam collects at the drain box and can prohibit waste water from draining properly. Rinse only one group at a time. Rinsing multiple groups simultaneously could cause the drain box to overflow.</p> </div>

Troubleshooting

- This espresso machine is equipped with several feedback mechanisms that alert the operator when an unusual condition occurs. Additionally the espresso machine will warn the operator when certain parameters fall below or above the programmed point. These errors and warnings will appear as a message in the display.
- The following section will describe errors and warnings that may appear in the display

Message	Description	Message Solution
First installat. Enter to confirm	This is the first installation of the espresso machine and the CPU is asking for verification of this event.	Press the ENTER button on group 1 keypad to confirm. Then will initialize the CPU and boot the electronics.
Coffee boiler filled?	This message is displayed after the boilers have been drained. The CPU is verifying that the coffee boiler is full.	Fill the coffee boiler with water (see operating manual for detailed instructions). Ensure that all air is bled from the coffee boiler using the air bleed screw atop each group casting. The CPU will display this message to ensure that the coffee boiler is full before supplying power to the coffee boiler heating element.
Corrupted Data	This message is displayed when the CPU does not understand an instruction.	Most likely the machine power was disconnected with out first turning off the machine through the keypad and display. Turn off machine using main switch to cycly power on and off. This should clear the error.
Filling-up in progress	This message is displayed when the steam boiler autofill cycle is activated and water is entering the steam boiler.	No action is required when this message is displayed. This message is only displayed to notify the operator of the active process.
Filling-up Alarm	This message is displayed when the CPU does not detect a full signal from the steam boiler within the set time interval.	When this message is displayed the CPU also shuts down and turns off power to the machine (see the parameter "Level Timeout"). Press the ON/OFF button to reset this error.
Steam Boiler Empty	This message is displayed when the CPU does not receive any signal from the Safety Probe in the steam boiler.	When this message is displayed the CPU turns off power to the steam boiler heating element. The only way to reset this error is to repair the Safety Probe to restore the signal to the CPU.
Steam Boiler Temperature	This message is displayed when the steam boiler temperature exceeds the maximum allowed temperature.	When this message is displayed call an authorized service technician to repair this fault. The also CPU turns power off to the steam boiler.
Flowmeter Alarm	This message is displayed when the CPU does not receive the appropriate signal from the flowmeter.	When the flowmeter alarm is displayed, the light on the corresponding button that initiated the brew cycle will begin to flash. This problem is a result of water not flowing through the flow meter. This can be caused by the coffee packed too tightly, a blockage in the tubes, a malfunctioning water pump, a faulty valve, or a damaged flowmeter. Call a service technician to fix this problem.
Coffee Boiler 1 Heating	This message is displayed when the coffee boiler does not reach the minimum temperature with the programmed time interval.	See the parameter "Heating Timeout" for more information. The number on the display corresponds to the number of the faulty coffee boiler.
Coffee Boiler Temperature	This message is displayed when the coffee boiler temperature exceeds the maximum allowed temperature.	If this happens call an authorized service technician to repair this fault. When this message is displayed the CPU turns power off to the coffee boiler displayed. The number in the display corresponds to the faulty coffee boiler.
Autosteam 1 Temperature	This message is displayed when the autosteam temperature exceeds the maximum allowed temperature.	If this happens call an authorized service technician to repair this fault. The number in this message indicates the faulty Autosteam assembly.
Wrong Password	This message is displayed when password entered does not match the programmed password.	This error message will be displayed anytime an incorrect password is entered. The display will reset automatically after 3 seconds. Then an additional attempt may be made.



HANDMADE IN FLORENCE

EE - Table of Contents

EE Programming Introduction	pag 61
Accessing Programming Mode	pag 62
Coffee Boiler Temperature (example description for all parameters)	pag 63

EE Programming Introduction

Description

- This espresso machine has a very powerful CPU and many configurable settings.
- Additionally, there are many feedback controls employed in this espresso machine to troubleshoot problems should they occur.
- The following is a brief introduction to the controls and display and how they interact with the operator.

Digital Display



The digital display (display) is a backlit display capable of displaying 2 lines of 16 characters. The display enables the operator to interact with the espresso machine to visibly change parameter values. The display also provides valuable information to the operator. There are several warnings that can be displayed to alert the operator of an unusual condition or a fault. Additionally, simple messages are displayed alerting the operator that an action has been started or that a process needs to begin.



Programming Keypad

BREW BUTTON

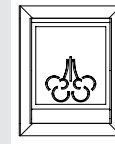

TEA BUTTON



The first group  and the second group  buttons are used to change the values of the individual parameters. The first one increase the value, the second one decrease it. Use these button even if it's a 3 or 4 group coffee machine.



The  button is used to scroll through the menu. Additionally, this button also confirms some values within the parameters.

EE Accessing Programming Mode

EE Programming Mode



Description

- To change any configurable parameter the operator must first enter into the programming mode.
- There are two levels within the programming mode that allow the restriction of specific parameters depending upon procedure entered.

The two programming levels are as follows:

- Barista Programming. Limited parameters are available.
- Factory Programming. Barista level parameters plus additional parameters are available.

Parameters description: See the Table of Contents of AV Model

The parameters are the same of the AV Model, the only difference is the use of the push buttons as described on previous page.

Operating Procedure

Barista Level

- 1 Turn off the main-switch (O position/ Off position)
- 2 Press and hold the tea button and turn on the main switch (1 position/On position) until the first of the following menu appears:
 - 1 COFFEE BOILER T.
 - 2 CUP HEATING
 - 3 TOTAL COFFEE
 - 4 TOTAL TEA
 - 5 LANGUAGE
 - 6 TEMPERATURE C/F
 - 7 PRE-BREWING (AVAILABLE FROM THE 1.18 SOFTWARE VERSION)
 - 8 CRONO FUNCTION (AVAILABLE FROM THE 1.06 SOFTWARE VERSION)
 - 9 USER NAME
 - 10 OFF

Factory Level

- 1 Turn off the main-switch (O position/ Off position)
- 2 Press and hold the first and the second brew button from the left and turn on the main switch (1 position/On position) until the first of the following menu appears:

1 COFFEE BOILER T.	10 TEMPERATURE CORRECTION
2 CUP HEATING	11 FILLING UP
3 TOTAL COFFEE	12 TEA WATER FILLING
4 TOTAL TEA	13 GROUP NUMBER
5 LANGUAGE	14 KP KI KD
6 TEMPERATURE C/F	15 PID RANGE
7 PRE-BREWING (AVAILABLE FROM THE 1.18 SOFTWARE VERSION)	16 HEATING TIME OUT
8 CRONO FUNCTION (AVAILABLE FROM THE 1.06 SOFTWARE VERSION)	17 LEVEL PROBE DELAY
9 USER NAME	18 LEVEL TIME OUT
	19 OFF

When finished, scroll through the OFF parameter with the tea button and push any BREW BOTTON to turn the machine ON.







Boiler Parameters

(Barista Programming Example) Nominal Coffee Boiler Temperature

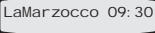
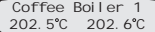

Description

- This parameter is set at the factory at a preset nominal temperature.
- The set temperature of this parameter differs from the actual temperature of the water exiting the group to the coffee.
- To set the temperature of any espresso machine it is important to measure the temperature of the water exiting the group.







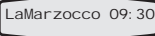
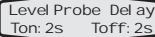

Display	Operating Procedure
	<p>1 Turn off the main-switch (O position/ Off position)</p>
	<p>2 Press and hold the  button and turn on the main switch (1 position/On position) until the following is displayed (approximately 10 seconds):</p>
	<p>3 Press the first  or the second  button from the left to change the temperature on the displayed boiler. The measured temperature appears on the left and the set temperature appears on the right side of the display. Once the desired temperature is selected press the  button to confirm the selection and go through the menu.</p> <p>4 When finished, scroll through the OFF parameter with the  button and push any  button</p>

(Factory Programming Example) Steam Boiler Level Delay



Description

- This parameter is safety feature that consider the motion of the water inside of the steam boiler.

Display	Operating Procedure
	<p>1 Turn off the main-switch (O position/ Off position)</p>
	<p>2 Press and hold the first  and the second  button and turn on the main switch (1 position/On position) until the following is displayed (approximately 10 seconds):</p>
	<p>3 Press the  or the  button to change the value of the parameter. When the desired value is displayed press to  confirm value.</p> <p>4 When finished, scroll through the OFF parameter with the  button and push any  button</p>

